



RESIDENTIAL INSTALLATION MANUAL SWIM JOY SOLAR POOL HEATER

Before attempting installation, read these instructions and acquaint yourself with the component names. Great care has been taken to make this an easy-to-follow procedure. A little time spent understanding the system and its parts will assure a successful, trouble-free installation.

CAUTION: SAFETY COMES FIRST

When working on or around your roof or pool, please take care to avoid hazards such as electrical wires and loose shingles.

1406 | Rev. 05

STR-INSTALL | 1406



1. Introduction/Table of Contents.

Swim Joy collectors are manufactured utilizing cutting edge technology and the most advanced production techniques. A Swim Joy solar system will provide years of worry-free performance as it captures safe, reliable heat from the sun year after year.

This manual will give you a great deal of valuable information. Take time and read through this manual. It will guide you through the most efficient way to correctly install an Swim Joy solar system. By following this step-by-step guide, your system will meet the installation standards recommended by the factory.

While the manual explains how to install Swim Joy solar panels properly in typical situations, it cannot address all the unique or individual circumstances possible. If you have any installation questions, contact your Swim Joy Representative for assistance. As the installing contractor, you are responsible for exercising good judgment when installing Swim Joy systems to protect the long term integrity of the collectors as well as the mounting surfaces.

1	1. Introduction.	22	12. Running the Feed & Return Lines From Roof to Ground Level.
2	2. Getting Started.		
3	3. Things to Remember.	24	13. Connecting the Feed & Return Lines to the Filtration System.
5	4. Installation Kits & Components.		Repair Procedures.
6	5. Parts Breakdown.	27	14. Pressure Testing the Swim Joy Solar System.
7	6. Solar Panel Layout & Hydraulics.	28	15. Operation & Check-out Procedures.
12	7. Connecting the Solar Connectors Together.	30	16. Troubleshooting.
14	8. Mounting the Solar Panels Using Swim Joy Mounts.	34	17. Repair Procedures.
19	9. Mounting the Solar Panels on a Flat Roof.		
20	10. Assembly of Row Spacer Kits.		
21	11. Connecting the Collectors to the Feed & Return Lines.		

2. Getting Started.

BEFORE YOU START YOUR INSTALLATION, HERE ARE A FEW IMPORTANT TIPS:

1. **Caution - SAFETY COMES FIRST!**
There is no substitute for safety. Always exercise extreme caution, care, and good judgment when working on or around a roof or pool area.
 - **Please take care to avoid hazards such as overhead electrical wires or loose shingles.**
 - **Be sure to secure ladders so they will not slip or fall.**
 - **Do not allow extension cords to lie in the pool or in standing water.**
 - **Wear shoes with proper tread to prevent slipping on the ladder or sloped roof areas.**
 - **Disconnect all power to the pool equipment when installing an automatic control system.**
2. *Check with your local building department to determine permitting and code requirements in your area.*
3. *While this manual explains how to install Swim Joy solar collectors properly in typical situations, it cannot possibly address all the unique or individual circumstances possible. If you have any installation questions, contact your Swim Joy representative for assistance.*
4. *Before starting any work, determine the location of your system and prepare a schematic drawing of the installation area. Include the location of the feed and the return lines in this drawing. Roof areas often times look bigger than they really are, so be sure to measure the available area before making your schematic. Be sure that the layout of the collectors will allow the collectors to drain when the pool pump shuts off.*
5. *Familiarize yourself with all of the Swim Joy components and plumbing materials that you will need to complete the installation.*
6. *Don't take shortcuts. Whenever possible, panels should be installed so they are accessible without being walked on. Walking on the collectors should only take place when absolutely necessary.*
7. *Depending upon your specific job, you will need various plumbing items and materials. Be sure to use quality products that will withstand direct sunlight year after year.*

PVC PIPE - Use PVC SCHEDULE 40 pressure rated pipe. Do not use ABS or a lower standard substitute.

PVC FITTINGS - Use PVC SCHEDULE 40 pressure rated fitting to match your PVC pipe.

DO NOT USE - "plumber's" fittings or DWV fittings (drain, waste, vent).

PVC CLEANER AND CEMENT - It is important to both CLEAN and CEMENT each PVC joint. When gluing CPVC fittings to PVC pipe, such as the (117) pipe connector, it is necessary to use a good quality **multi-purpose cement**.

NOTE: *As the installer, you are responsible for exercising good judgment when installing Swim Joy systems to protect the long term integrity of the collectors as well as the mounting surfaces.*



3. Things to Remember.

NO TWO INSTALLATIONS ARE EXACTLY ALIKE BUT THERE ARE SOME GENERAL BITS OF TECHNICAL INFORMATION THAT YOU WILL FIND HELPFUL IN THE FIELD.

ROOF ORIENTATION - Ideally, collectors should be located on a south facing or flat roof or on an elevated ground mounted rack facing south. The next best orientation is west and finally east. Collectors should never be installed facing north in the Northern hemisphere.

COLLECTOR CONFIGURATIONS - There are many ways to configure a solar array. The most common and preferred is in a continuous row. The recommended limit to the number of collectors that can be installed this way to achieve even flow throughout the array is (12) SJ-30's, (10) SJ-40's, or (8) SJ-50's.

This maximum guideline can be exceeded if there is a high flow or substantial back pressure on the system which will force adequate flow through every collector. When you have more than the maximum, you should either use the double row layout or the single row split feed layout. Of course, the double row can also be used for smaller installations when space is a problem. (Fig. 6.2, page 7).

If you have to split up an array due to a skylight or change in roof level or direction, the layout will be similar to single row split feed layout.

PUMP HORSEPOWER - The horsepower of your swimming pool filtration pump must be adequate to supply the solar system with enough water to provide the recommended flow rate necessary for the collectors being installed. The recommended rates are:

PANELS	RECOMMENDED FLOW
SJ-30	3-4 gallons per minute
SJ-40	4-5 gallons per minute
SJ-50	6-7 gallons per minute

Generally, a 1-horsepower pump is sufficient for a standard pool solar system unless there is an unusually long pipe run, a high roof or a large number of collectors. If you are not sure what your pump flow rate is, consult your Swim Joy representative for the pump's flow characteristics.

PLUMBING - It is important that you use the proper size PVC pipe for the size of the solar array. Under sizing the pipe will produce too much restriction to the water flow and unnecessarily reduce the flow rate to the collectors. Use the following as a guide:

FLOW RATE	MINIMUM PIPE SIZE
0 to 30 GPM	1½"
31 to 50 GPM	2"
51 to 70 GPM	2½"

Plumbing runs should be as short as possible and the "hot return" pipe should have the shortest run to reduce the potential heat loss in the pipe. Horizontal pipes should be supported with a pipe clamp at least every 4 feet to prevent sagging. The pipe clamp used on pipe runs across a roof should be ½" larger than the pipe diameter to allow for expansion and contraction. Pipe clamps should be used on vertical or horizontal runs on the side of a building and should be the same size as the pipe diameter to prevent movement.

3. Things to Remember, - Cont.

AUTOMATIC DRAIN DOWN - *The collectors and the PVC pipe should be installed so the water will drain out of them when the pump shuts off. This is especially important in areas of the country where freezing conditions occur.*

The Swim Joy solar pool collectors are warranted against internal freezing when installed to allow for drain down. If, as a result of a unique roof design or adverse pool equipment locations, it is not possible to achieve complete automatic drain down, manual drain down valves should be installed in appropriate places in the plumbing or at the end of the bottom (feed) header.

[Instead of installing an end cap (2-1410-013) at the end of the header, you would place a (2-1410-005) type connector (2-1410-004) 1½" x 1½" THD PVC reducer bushing along with a ½" boiler drain (1-5115-017)].

These valves should be opened when shutting down the system for the winter months or when freezing conditions are possible. Your Swim Joy representative can assist you with the parts necessary for manual drain down installations.



4. Installation Kits & Components.

The following is a description of the installation kits that are required for a complete Swim Joy installation. The (2-1145-006) system kit and (2-1045-001) collector kits are always required while the (2-3045-003) row spacer kit is only required for certain installations. The (2-3020-022) pressure testing kit is used at the end of the installation to test the system while the (2-3020-025) repair tool kit is used if you ever need to repair a collector.

2-1045-001: COLLECTOR KIT

One of these kits is required for each collector it contains: (1) (2-1410-005) plastic panel clamp, (2) 2-1160-002, and (2) SJ-MPT.

2-1145-006: SYSTEM KIT

One of these kits is required for each row or bank of collectors. It contains the parts necessary to connect the collectors to the feed and return lines.

2-3045-003: ROW SPACER KIT

One of these kits is required if you need to bypass a vent pipe, or obstacle larger than 6". It is also used to connect collectors into one row that are on different roof levels or that are facing different directions. It contains the part necessary to connect the collectors to the PVC pipe between them.

2-3020-022: PRESSURE TESTING KIT

This kit gives you the components you need to pressure test the system once installation is complete.

2-3020-025: REPAIR TOOL KIT

In the event a collector is damaged, this kit contains everything needed to make a repair to a riser tube.

MISCELLANEOUS - Depending upon your specific job, you will need other plumbing items and materials such as: PVC valves, stainless steel lag bolts, polyurethane caulk, silicone spray, pipe straps, black electrical wire ties, electrical wire nuts, 18ga-22ga sensor wire, 12ga-14ga electrical wire with ground, Teflon tape, concrete anchors and screws, electrical conduit, etc. Be sure to use quality products that will withstand direct sunlight year after year.

- **Flat head and Phillips head screwdriver**
- **Power drill with bits, 5/16" and 7/16" sockets**
- **Pipe cutter or hacksaw**
- **Garden hose**
- **Channel lock pliers**
- **Caulking gun**
- **Ladder**

NOTE: While this manual explains how to install Swim Joy solar panels properly in typical situations, it cannot address all the unique or individual circumstances possible. If you have any installation questions, contact your Swim Joy representative for assistance. As the installing contractor, you are responsible for exercising good judgment when installing Swim Joy systems to protect the long term integrity of the collectors as well as the mounting surfaces.

5. Parts Breakdown.

PART NO.	DESCRIPTION	2-1145-004	2-3045-001	2-3045-003	2-3020-022	2-3020-025
2-1160-003	Top Mounting Pad	2				
2-1410-004	Panel Clamp with Gasket	2	2	2		
2-1410-005	Pipe Connector		2	4		
2-1410-013	End Cap		2			
2-1160-002	Bottom Mounting Pad	2				
1-5115-023	½" ball valve				1	
2-3020-001	0-60 PSI Pressure Gauge				1	
2-2015-101	Pressure Test "T" Assembly				1	
2-1410-007	Pin Insert Tool					1
2-1410-008	¼" Chisel					1

OTHER INSTALLATION COMPONENTS

2-1410-023 Vacuum Breaker	2-2015-010 PVC 2" Check Valve
2-2000-015 Pipe Clamp	OV2-2010 Two Way Ball Valve
1-5060-011 1/4" x 4" S.S Lag bolt	OV3-1500-NP Three-Way Valve
2-1020-004 Tap Cons 1/4"x1-3/4' w/ Drill Bit	2-1910-017 Gasket for Panel Clamp
2-1020-007 Repair Plugs	

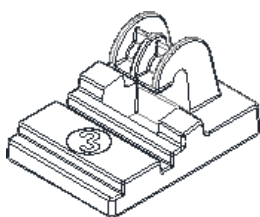

2-1160-003

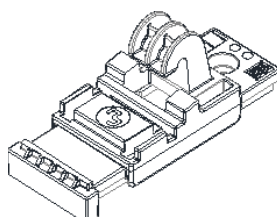

2-1160-002

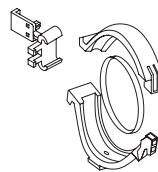

2-1410-004

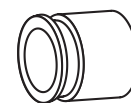

2-1410-005



2-1410-013



2-3020-001

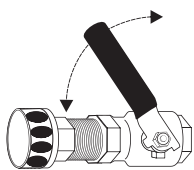

1-5115-023
½" BALL VALVE

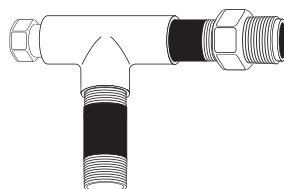

2-2015-101
PRESSURE TEST "T"
ASSEMBLY KIT

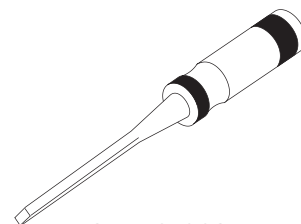

2-1410-008
¼" CHISEL



2-1410-007
PIN INSERTION TOOL

6. Solar Panel Layouts & Hydraulics.

Shown below are the 5 most common solar collector installations.

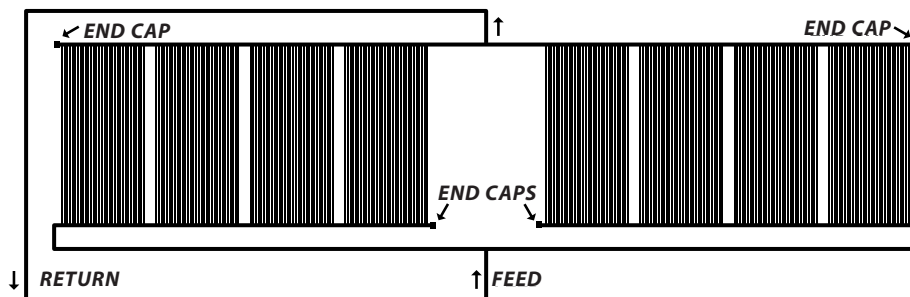
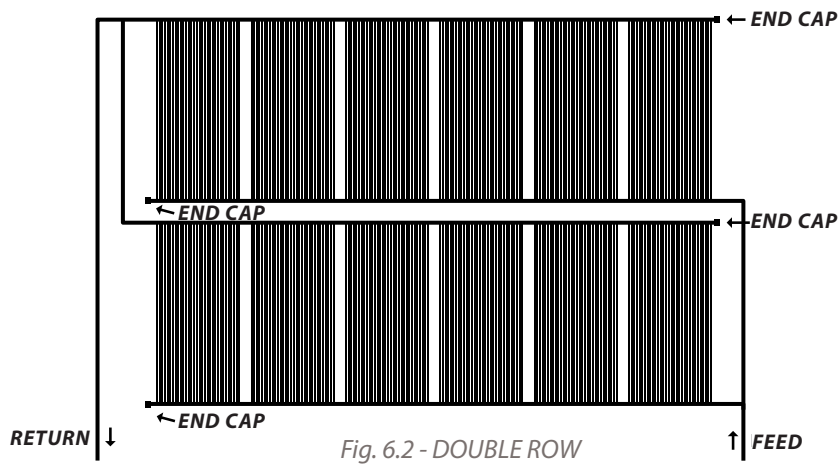
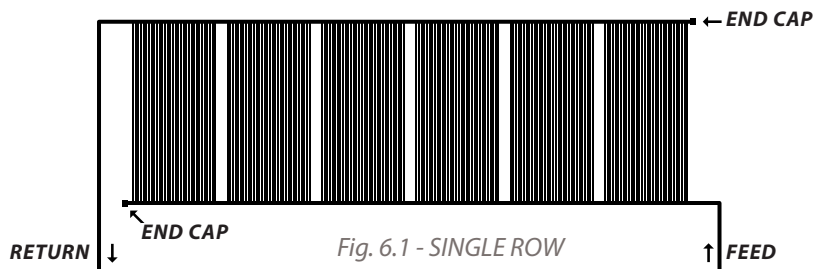

6. Solar Panel Layouts & Hydraulics. - Cont.

Shown below are the some common solar collector installations.

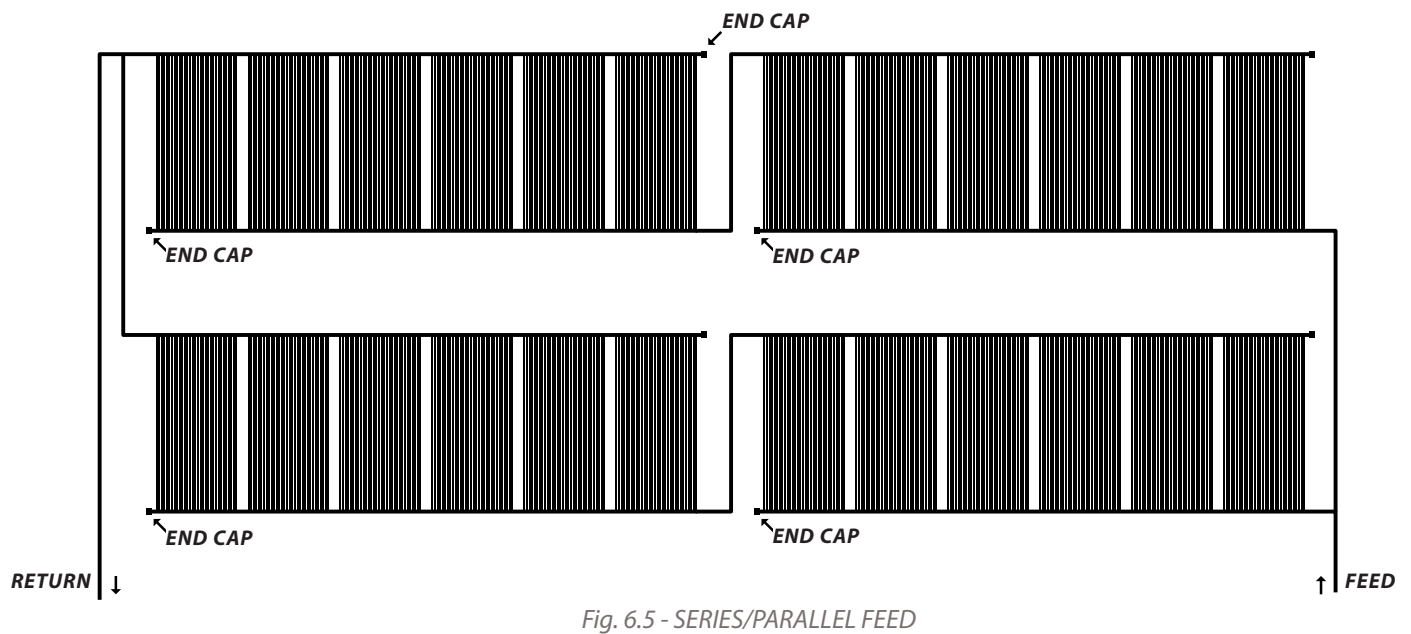
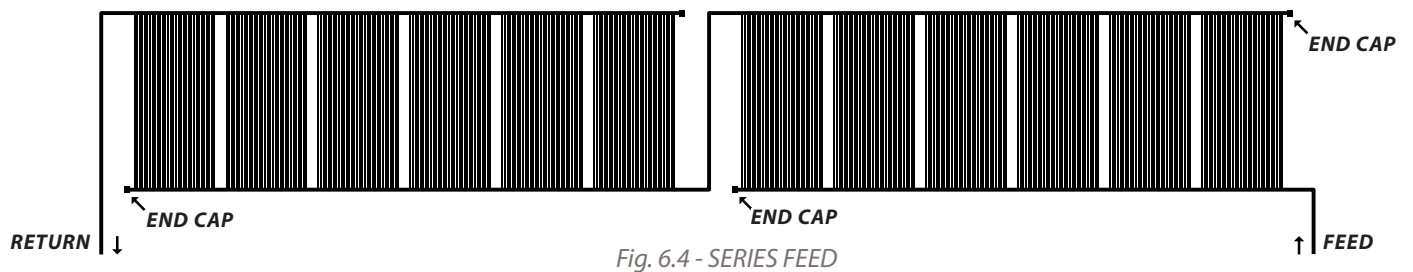



6. Solar Panel Layouts & Hydraulics. - Cont.

ROOF ORIENTATION - Ideally, collectors should be located on a south-facing or flat roof on an elevated ground mounted rack facing south. The next best orientation is west and finally east. A collector should never be installed on a north roof without a reverse rack in the Northern hemisphere.

CHOOSING THE RIGHT SIZE COLLECTOR - The roof space available to you will determine which model collector to use. Since Swim Joy manufactures collectors in eight different sizes, you have great flexibility in what you can design. The eight panels sizes are:

PANEL	SIZE
SJ-8	1' x 8'
SJ-9.5	1' x 9.5'
SJ-10.5	1' x 10.5'
SJ-12.5	1' x 12.5'
SJ-30	4' x 8'
SJ-38	4' x 9.5'
SJ-40	4' x 10.5'
SJ-50	4' x 12.5'

Whenever possible, the largest panel (SJ-50) should be used. This will:

- Reduce your total collector cost.
- Reduce labor and installation material cost.
- Reduce the length of the solar array.
- Reduce the number of roof penetrations.
- Produce a more attractive installation.

However, unique roof designs may require a combination of different size collectors to best cover the roof area.

PANEL CONFIGURATIONS - There are many ways to configure a solar array. The most common and preferred is in one continuous row as shown in Fig. 6.1, page 7. However, there are, recommended limits to the number of panels that can be installed this way to achieve even flow throughout the array. The maximums are:

MODEL #	MAXIMUM PER ROW
SJ-30	12
SJ-40	10
SJ-50	8

These maximums can be exceeded if there is high flow or substantial back pressure on the system, which will force adequate flow through every panel. When you have more than the maximums, you should either use the double row layout as in Fig. 6.2 or the single row split feed layout as in Fig. 6.3, page 7. Of course, the double row can also be used for smaller installations when space is a problem.

6. Solar Panel Layouts & Hydraulics. - Cont.

PUMP HORSEPOWER - The horsepower of your swimming pool filtration pump must be adequate to supply the solar system with enough water to provide the recommended flow rate necessary for the panels being installed. These recommended rates in gallons per minute (GPM) are (0.1gal/ft²).

MODEL #	MINIMUM FLOW
SJ-10.5	1 GPM
SJ-12.5	1 GPM
SJ-30	3 GPM
SJ-40	4 GPM
SJ-50	5 GPM

For example: If you are installing (10) SJ-40 panels, your pump must be able to deliver 40 GPM to the solar array. These flow rates may be exceeded by as much as 100% without any detrimental impact on the performance of the system. The existing pool recirculation pump is typically adequate for recirculating the water through the solar system. Generally, a 1-horsepower pump is sufficient for a standard pool solar system unless there is an unusually long pipe run, a high roof, or a large number of panels. *If you are not sure what your pump flow rate is, consult your Swim Joy representative or pump manufacturer for the pump's flow characteristics.*

PLUMBING - It is important that you use the proper size PVC pipe for the size of the solar array. Under sizing the pipe will produce too much restriction to the water flow and unnecessarily reduce the flow rate to the panels. Use the following as a guide:

FLOW RATE	MINIMUM PIPE SIZE
0 to 30 GPM	1½"
31 to 50 GPM	2"
51 to 70 GPM	2½"

For larger flow rates, consult your Swim Joy representative for the proper pipe size or alternative series plumbing techniques, which will reduce the necessary flow rates on larger systems.

Plumbing runs should be as short as possible and the "hot return" pipe should have the shortest run to reduce potential heat loss in this pipe. Pipes should be supported with pipe clamps or "G" clamps at least every 4 feet to prevent sagging. (Check with plumbing code in local jurisdiction.) The pipe clamp used on pipe returns across a roof should be ½" larger than the pipe diameter to allow for expansion and contraction. The pipe clamp used on vertical or horizontal runs on the same side of the building should be the same size as the pipe diameter to prevent vibration and to assure a professional looking installation.

Since 90-degree elbow fittings produce a high restriction to flow, you will want to use as few as possible; keep this in mind when planning your plumbing runs. Their use cannot be avoided, but with careful forethought, you will use the least number possible. Occasionally, the use of (2) 45-degree fittings will eliminate a 90, but it is not necessary to always use them as this will run up the expense of your materials.



6. Solar Panel Layouts & Hydraulics. - Cont.

BALANCED FLOW - When you have to split a solar system as in Fig. 6.2 or Fig. 6.3, page 7, it is critical that the shown plumbing runs be followed to assure equal water flow through both rows of panels. Since water will follow the path of least resistance, if one plumbing run is shorter than the other, more water will flow through it than through the other one. Keep this in mind if you design a panel layout different than the examples. *Your Swim Joy representative can also assist with this and explain the use of "balancing valves" on larger systems.*

If you are installing the solar panels on a flat roof or flat ground rack, the top (return) header of the panel should be at least 3" higher than the bottom (feed) header to assure equal flow through all of the tubes of all the panels. To achieve even distribution of water throughout the row of panels, proper flow rates and a little back pressure should be present.

AUTOMATIC DRAIN DOWN - The panels and the PVC pipe should be installed so the water will drain out of them when the pool pump shuts off. This is especially important in areas of the country where freezing conditions occur. (The Swim Joy solar pool panels are warranted against internal freezing when installed to allow for drain down.) To allow for the water to drain, a vacuum breaker (2-1410-023) is installed on the solar feed line above the non-positive three-way valve as shown in (Fig. 13.1, page 24). (Non-positive means that the valve allows for water to drain back through the valve even while in the off position. If you have a 3-way valve that is not non-positive, you can make it so by drilling an 1/8" hole in the diverter). If, as a result, of a unique roof design or adverse pool equipment location, it is not possible to achieve complete automatic drain down, manual drain down valves should be installed in appropriate places in the plumbing or at the end of the bottom (feed) header.

Instead of installing an end cap (2-1410-013) at the end of the header, you would place a pipe connector, and (2-1410-005) 1½" slip x 1½" threaded PVC reducer bushing, along with a ½" boiler drain 1-5115-017. These valves should be opened when shutting down the system for the winter months or when freezing conditions are possible. Your Swim Joy representative can assist you with the parts necessary for the manual drain down installations.

7. Connecting the Solar Panels Together.

Later on in this installation manual you will be instructed to connect the collectors together using (2-1410-005) plastic panel clamps. When connecting collectors together, follow the directions outlined below:

1. Place two collectors next to each other. The spacer bars that hold the individual riser tubes together should be facing down. Lay a plastic panel clamp (2-1410-004) top, bottom, gasket and clip where the two headers meet. (Fig. 7.1-A)
2. Clean the groove of both headers.
3. Spray the gasket with silicone and insert it into the groove of one of the headers. Make sure that the gasket is fully seated into the header groove by pushing firmly with your thumb all the way around the gasket. (Fig 7.1-B)
4. Place the bottom half (see Fig. 7.1) of the plastic panel clamp (2-1410-004) under the collector header with the hook portion of the panel clamp on the inside of the collectors. (Fig. 7.1-C)
5. Seat both headers together by inserting the gasket into the opposite header groove and placing the ends of both headers into the open space in the panel clamp bottom. (Fig. 7.1-D)
6. Interlock the top half of the panel clamp with the hook on the bottom half. Swing top half over top of collector headers. Squeeze the top and bottom portions of the panel clamp together using channel lock pliers and lock both halves of the clamp together using the locking clip. (NOTE: Slide large end of locking clip over small end of plastic panel clamp assembly) (Fig. 7.1 - E & F)
7. Use channel lock pliers to tighten the clip grip by squeezing it with reasonable force until it seats flush or even slightly farther so it cannot slide out of its position. (Fig. 7.1-G)
8. Push the clip interlock to prevent locking clip movement.
9. Use this same procedure to connect both top and bottom headers of the collectors.

NOTE: On soft roof surfaces or lesser quality asphalt shingle an EPDM or aluminum pad underneath the panel clamp may be necessary to eliminate possible wear.

SEE FIGURES ON NEXT PAGE

7. Connecting the Solar Panels Together. - Cont.

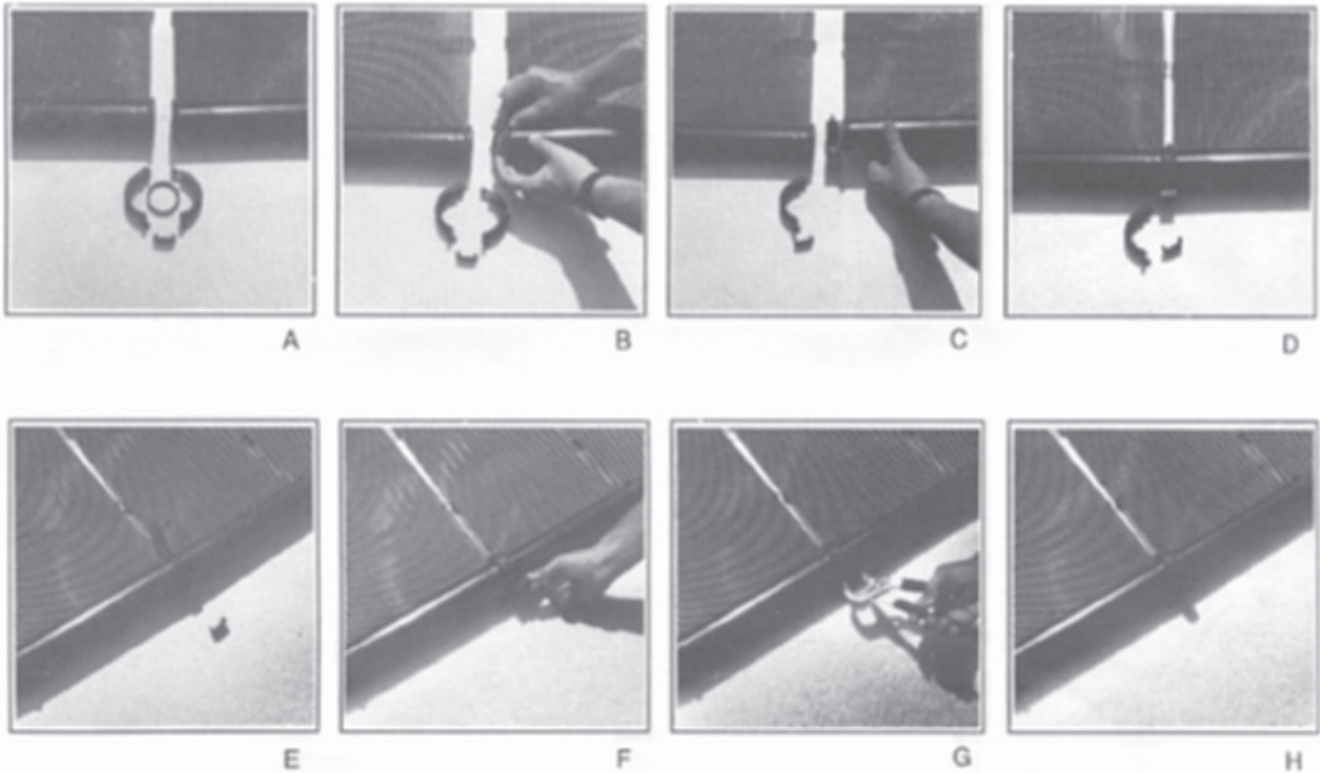

Fig. 7.1

8. Mounting the Solar Panels Using Swim Joy Mounts.

The most important feature of the Swim Joy installation method is its simplicity. The mounting pad's flexibility allows for the relatively simple installation of the Swim Joy collectors on any roof or rack surface regardless of pitch. To properly install collectors utilizing mounting pads follow these few steps:

1. Prepare each collector by sliding the (2-1160-003) mounting pad onto the mounting rail molded to the top header. (2) top pads per collector are required and should be located on the mounting sections of the collector. (2) mounting pads are also required at the bottom of the header.

Number of mounting pads required:

(2) on top header
(2) on bottom header

NOTE: Typically, each mounting pad should be centered on the mounting rail; however, the pad can be slid from side to side so that it can be centered on a roof truss or on the top of a barrel tile. You may even want to move the mounting pad to a different mounting rail, but remember to always keep the pads spaced out as evenly as possible.

2. Snap a chalk line across the roof where you want the top edge of the collector header to be. This chalk line should slope upward towards where the return line will be located, to allow for proper drainage. The return line corner of the collectors should be the top corner closest to the pool pump so that once the water is heated, it will be returning to the pool as quickly as possible. Be sure to allow 2" of clearance above this chalk line for the mounting pads.
3. Lay the first two collectors so that the top edge of the top header is located at the chalk line.
4. Connect the top headers of the collectors together using the (PPC) plastic panel clamp by following the procedures described in the section of this manual on connecting solar collectors together.
5. After positioning the mounting pads in the proper location, secure the first collector to the roof. Apply ample roof sealant to both lag bolts or appropriate roof fasteners and to the roof. Position mounting pad on the roof and lag to the roof. The (1-5060-011) ¼" x 4" lag bolt should be securely fastened, but not over tightened. In the case of tile roofs, tap cons are commonly used to attach the mounting pads to the tile. Using tap cons avoids the need to penetrate the roof membrane or substrate in cases where the roof tiles are properly anchored to the roof. On all types of roofs be sure to seal each penetration with the proper sealant.



Top S roof mounting pad "left".
Bottom S roof mounting pad "right".
(2) mounting pads required for each side.

Fig. 8.1





8. Mounting the Solar Panels Using Swim Joy Mounts. - Cont.

6. Before securing the next collector to the roof, connect an additional collector to the row using the plastic panel clamp. This allows you to lift up the header of the adjacent collector when connecting the two collectors together.
7. Install bottom mounting pads.
8. Follow the procedures listed above until all collectors are connected to each other and anchored to the roof.
9. After all collectors are anchored to the roof, connect the bottom headers together with additional plastic panel clamps.

The S Roof Mounting Pad is made up of two parts: top and bottom. Please use the following information as a guide for installation.

The bottom S Roof Mounting Pad set is created from two separate parts:

Slider

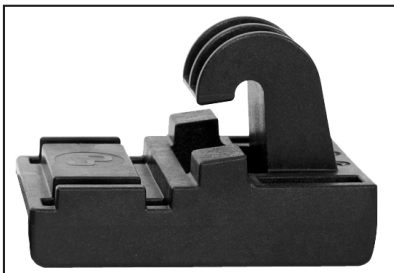

Track

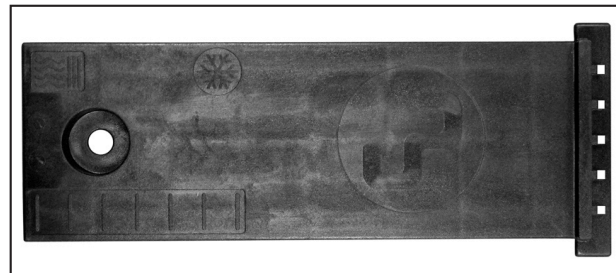

Slider and Track Assembly Together

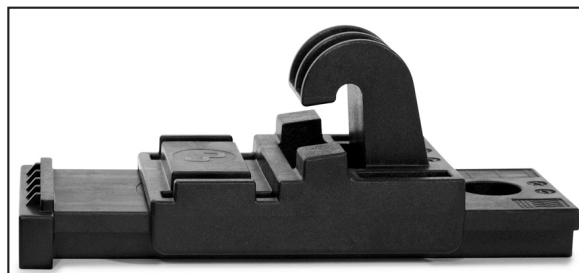

Fig. 8.2

8. Mounting the Solar Panels Using Swim Joy Mounts. - Cont.

The track of the bottom S Roof Mounting Pad set is very useful. Notice the graphic marks. These marks are here to assist you in determining how to position the mount during installation. Each symbol refers to a possible weather condition: "snowflake" for cold and "heat waves" for hot.

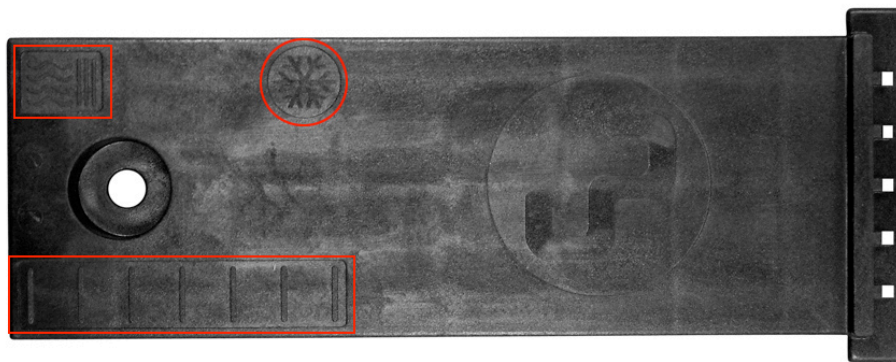

Fig. 8.3

As you know, the collector expands and contracts in correlation to the weather conditions. When it's hot outside, the collector is longer and when it's cold, the collector is shorter.

While installing the S Roof Mounting Pad, the installer should consider the current ambient temperature and position the slider over the track (and grid) so that it is closer to the icon that best defines the weather. This will allow enough room for the system to expand and contract as needed.

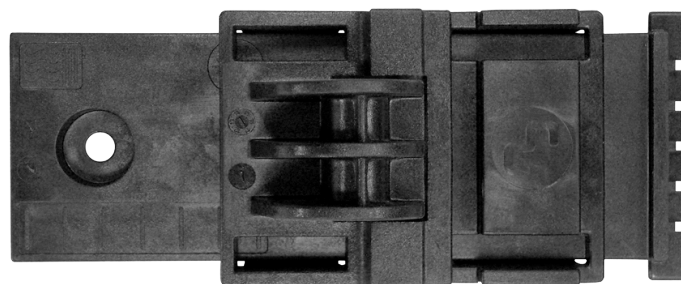
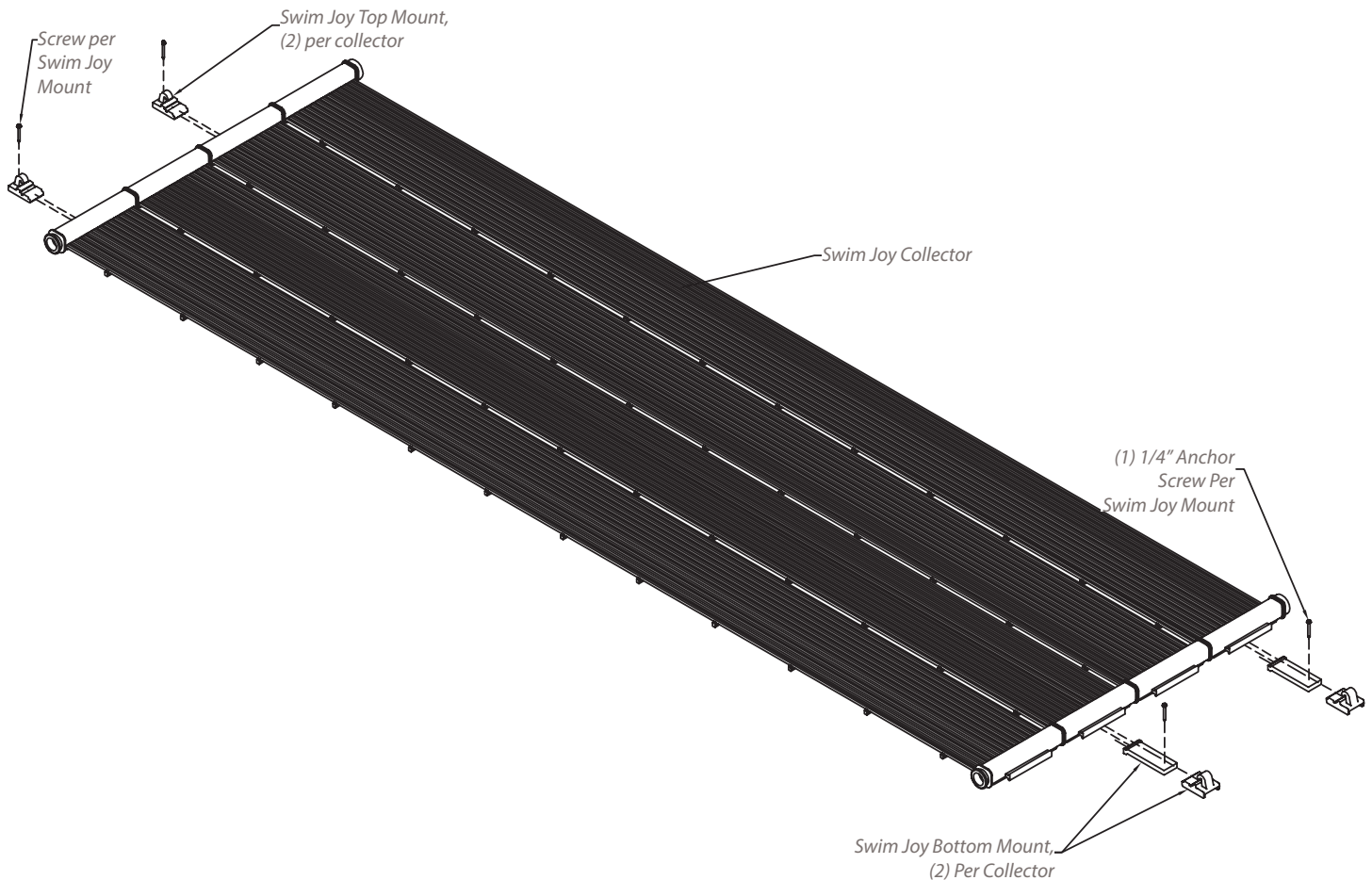

Fig. 8.4



8. Mounting the Solar Panels Using Swim Joy Mounts. - Cont.

Install (2) top S mounts and (2) bottom S mount set for each collector as illustrated in the sketch below.



(2) CLAMPS REQUIRED FOR EACH SIDE

Fig. 8.5

8. Mounting the Solar Panels Using Swim Joy Mounts. - Cont.

NOTE: As the installing contractor, it is your job to evaluate any site specific conditions that might create unwanted roof wear. As an example, if you are installing the system on an inexpensive or soft asphalt shingle roof, you'll want to put some 4" by 4" pads underneath each panel clamp along the bottom headers to prevent roof wear. Some installers make these pads from aluminum roof flashing or old mat systems, and attach them to the roof with roof sealant or an adhesive.

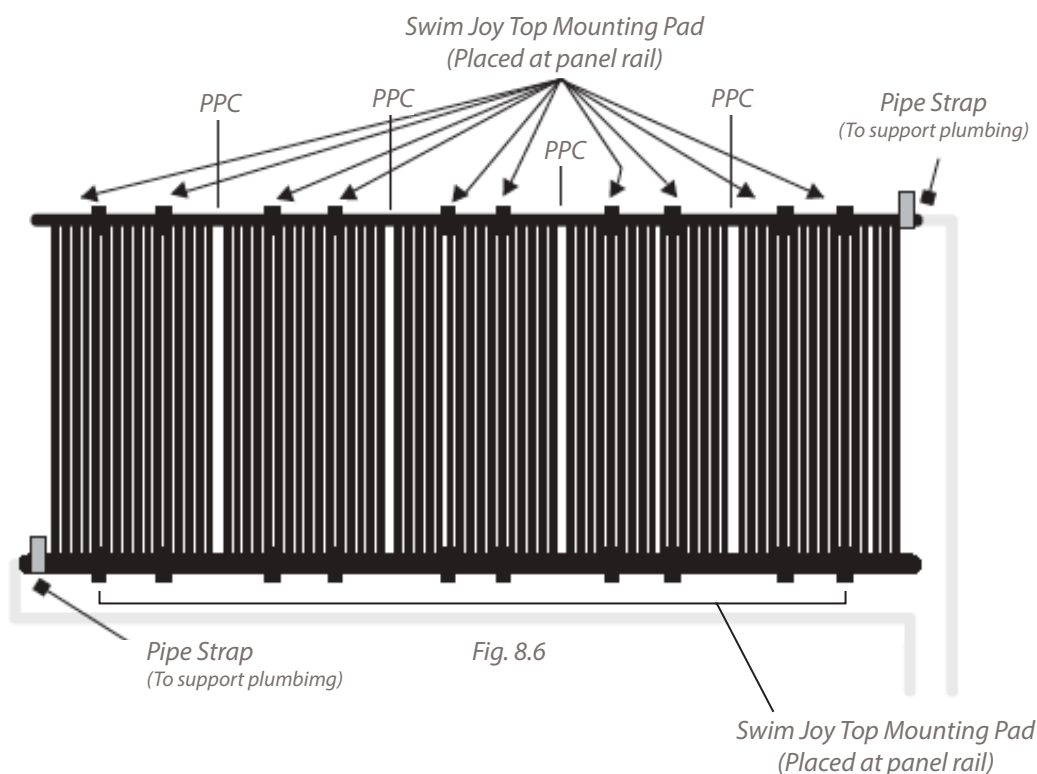

NOTE: Typical residential mounting plan shown. For additional mounting options for commercial installations please refer to addendum provided by manufacturer's engineering department.

NOTE: Install lower header based on temperature at the time of installation.



9. Mounting the Solar Panels On A Flat Roof.

If you have chosen a flat roof to mount the solar panels, it is recommended not to penetrate the surface with a lag bolt.

FIBERGLASS COATED, METAL, OR SHINGLED FLAT ROOF - If you have one of these three types of roofs with at least 3" of slope down the panel length, you can use the Swim Joy mounting pad method previously described. Use liquid adhesive to secure the Swim Joy mounting pads to the roof, or consult A.H.J. or engineer of record to make sure installation meets code regulations.

NOTE:

- **Whenever unglazed solar collectors are installed on a rack, a substrate should be mounted on the rack prior to mounting the panel. This eliminates heat loss and stress created by wind blowing on the back side of the rack. However, if this wind is eliminated by other site specific conditions, (e.g. windbreaks or fences) substrates are not necessarily required.**
- **There are all types of flat roof surfaces, and as the installing contractor, you are responsible for making sure that the installation will not damage the roof surface. If, for example, you have a very soft or rubberized roof surface, you'll want to protect the roof surface with some type of substrate. Alternatively, Swim Joy panels are designed so that they can be installed with the spacer bars facing up or down. You can flip the panels over for installations on these types of roofs.**
- **Please note that not all flat roof installations are the same. Please contact your local roofing contractor to ensure your meeting all local codes.**

10. Assembly of Row Spacer Kits.

When you need to install panels over an obstruction larger than 6' wide, or if the obstruction is less than 1' from a panel header, you'll need a row spacer kit to circumvent the obstruction.

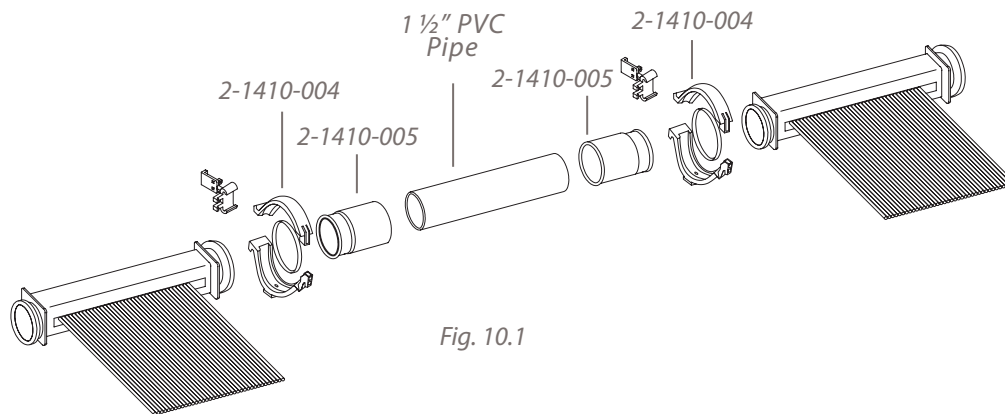

SJ-RSK

1. Connect (4) of the (2-1410-005) pipe connectors to the headers of the collectors to be connected with a (2-1410-004) plastic panel clamp using the same procedures outlined in the section on connecting solar collectors together on page 12.
2. Cut two lengths of 1-½" PVC pipe long enough to cement the (2-1410-005) pipe connectors on each collector to each other.
3. Cement the PVC pipe to the pipe connectors as shown in Fig. 10.1.
4. If the distance between the collectors is over 4', a 2" pipe clamp should be used on both pipes to prevent sagging.

NOTE: When gluing the (2-1410-005) CPVC pipe connectors, it is necessary to use good quality "multi-purpose" cement.



Fig. 10.2

Flexible riser tubes are snapped out of the spacer bars to go around small obstructions.

NOTE: Obstructions smaller than 6" can be circumvented by snapping the panel riser tubes out of the spacer bar and spreading them around the obstructions. (see Fig. 10.2).

WARNING - THIS SHOULD NOT BE DONE BETWEEN THE HEADER AND THE FIRST SPACER BAR AS IT WILL POSSIBLY PULL THE RISER TUBE OUT OF THE HEADER. THE SUNSTAR WARRANTY DOES NOT COVER LEAKS OCCURRING FROM THIS TYPE OF INCORRECT INSTALLATION. A ROW SPACER KIT SHOULD BE USED FOR THIS SITUATION.



11. Connecting the Solar Panels to the Feed & Return Lines.

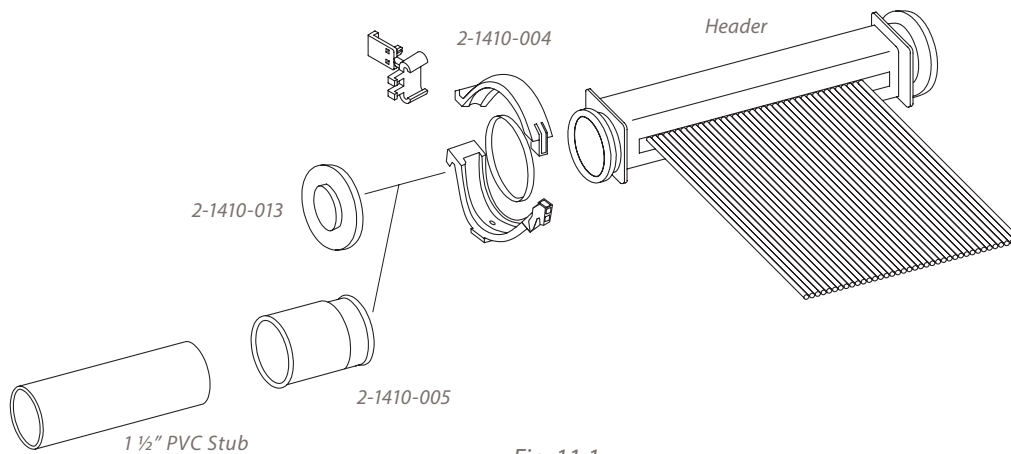

Fig. 11.1

1. The feed line will be connected to the low end of the bottom header as previously determined when the chalk line was snapped. This should be the end farthest from the pool pump. The return line will be connected to the top header on the opposite end of the array. This should be the end closest to the pool pump.
2. Attach the (2-1410-005) pipe connector to the corners of the array where the feed and return lines will be using the (2-1410-004) panel clamp as described in the section on connecting solar collectors together on page 12.
3. Cement the PVC pipe to the (2-1410-005) pipe connector as shown in Fig. 11.1.
4. The (2-1410-005) Pipe Connector allows (1) 1/2" PVC Pipe or a (1) 1/2" St. 90 to be glued directly into the socket, or a 2" PVC 90 to be glued on the outside. CPVC or **multi-purpose glue** should be used when attaching PVC fittings or pipe to the pipe connectors to provide for a durable connection. A 90 degree PVC fitting and vertical pipe run of at least 5' should always be attached to the return line pipe connector to allow for lateral expansion and contraction of the return line pipe run.
5. Connect the feed and return pipes using good plumbing techniques.
6. Attach the (2-1410-013) end caps on the corners opposite the feed and return lines using the (2-1410-004) panel clamps.

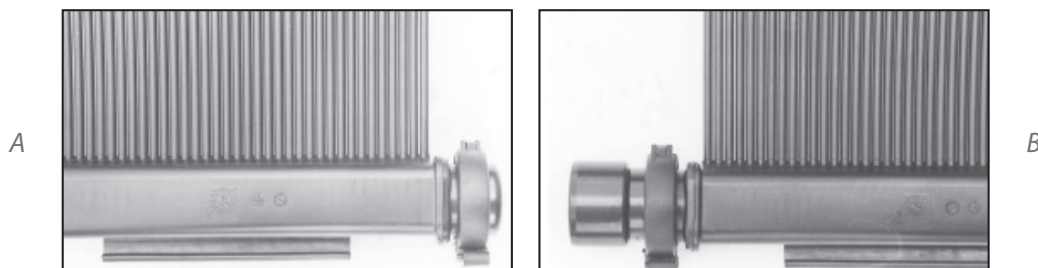

Fig. 11.2

12. Running the Feed & Return Lines From Roof to Ground Level.

Here is the standard, most straight-forward way of running the PVC pipe from the feed and return lines to the equipment pad. Some installations require a more creative approach due to unique roof designs or equipment pad locations. Whenever possible, the return line should have the shortest run and all pipes should run slightly “downhill” to allow for automatic drain-down of the plumbing and solar array. If this is not possible, manual drain valves should be installed as needed.

If your equipment pad is against your house, you may want to complete the necessary plumbing at the equipment pad before completing this portion of the installation. This allows you to know exactly where the pipe should come down from the roof. This is not necessary if you will be trenching from the equipment pad to the installation location.

1. Cement the appropriate size PVC 90-degree elbow to the return line stub facing down toward the bottom header. Repeat the process for the feed line header stub and face the elbow down away from the array. (see Fig. 12.1, page 23).

NOTE: Whenever cementing, lay a rag on the roof or rack under the joint to avoid dripping cement on the mounting surface. Also, it is a good idea to tape the cans of PVC cleaner and PVC cement together; they are less likely to tip over and spill this way.

2. Determine where the feed and return pipe will go over the edge of the roof. If possible, this should be perpendicular to the exact points where they will fasten into the existing system or into pipes coming from another location (see Fig. 13.1, page. 24).
3. Measure the distance from the return elbow down to the spot that you want to go, across the roof, to the point established above. **Be sure to include the depth of the socket in the elbow in your measurement.** Cut a piece of PVC pipe to this length. Repeat this process for the feed line.
4. If you are not experienced at cutting and fitting pipe, it is a good idea to assemble all pipe and fittings before cementing them just in case you make an error. Clean the burrs off of these cut pipe lengths and insert them into the elbows.
5. Measure across the roof from these pipes to the points established in Step 3. Cut and de-burr pipes to these lengths and assemble corner with 90-degree elbows.
6. Continue this process around the edge of the roof and down to the existing plumbing, keeping pipes as short, straight, and tight to the building as possible.
7. Once you are satisfied with the plumbing arrangement, go back and cement all of your joints together using the good plumbing techniques explained in the “Getting Started” section.
8. Secure long pipe runs with C-clamps or G-clamps one size larger than the pipe diameter using (1-5060-011) 1/4” x 4” stainless steel lag bolts and polyurethane caulk. Secure vertical pipe runs on the side of buildings with pipe-clamps the same size as the pipe diameter using screws and anchors as needed.

CONTINUES ON NEXT PAGE



12. Running the Feed & Return Lines From Roof to Ground Level. - Cont.

NOTE: All four corners of each row of panels should be securely fastened to the roof. The corners should already be secured with the Swim Joy mounting pads or pipe straps on the plumbing lines connected to the feed and return lines. The top corner opposite the return corner should already be secured by the panel mounting hardware.

NOTE: Be sure to support all of the weight of the plumbing with Swim Joy mounts or pipe straps. The mounting hardware is not designed to support the weight of the plumbing in addition to the weight of the collectors.

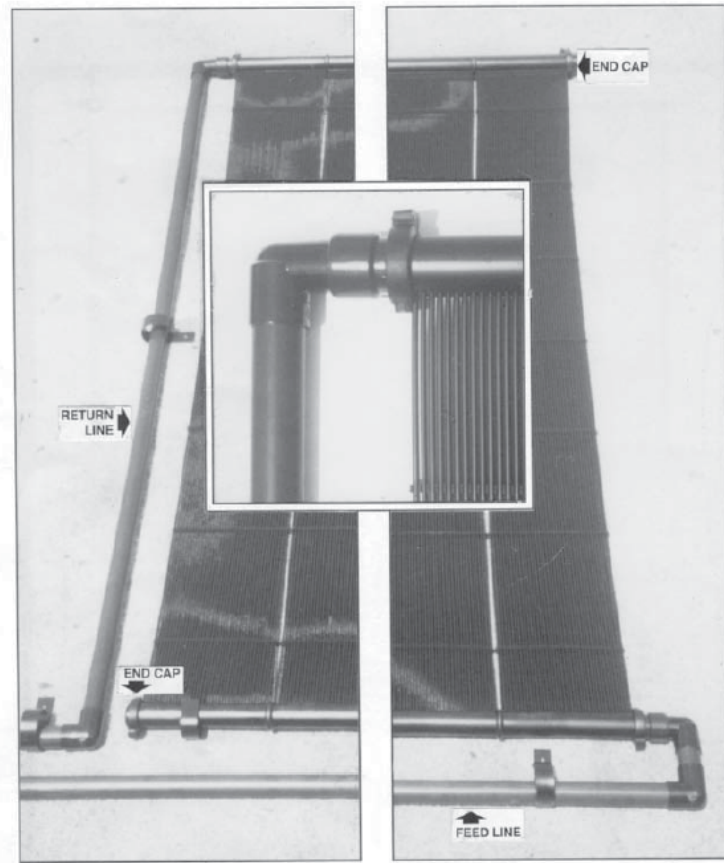

Fig. 12.1

The above photo (left) shows the return line attached to the top header and an end cap on the bottom header. The photo insert (center) the return line connection in detail.

The above photo (right) shows the feed line attached to the bottom header and an end cap attached to the top header.

13. Connecting the Feed & Return Lines to the Filtration System.

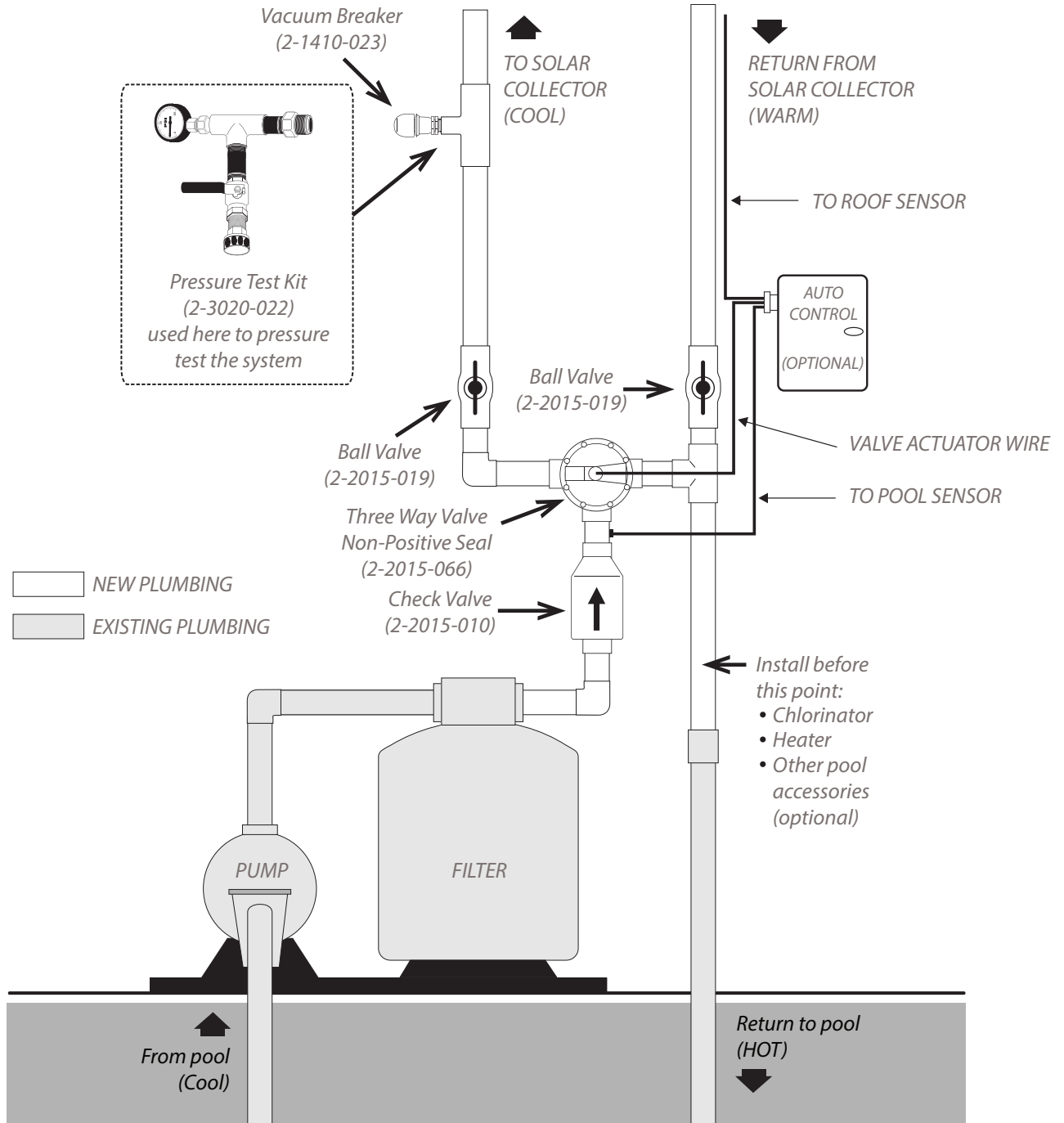

Fig. 13.1



13. Connecting the Feed & Return Lines to the Filtration System. - Cont.

Fig. 13.1 on page 24 shows how a typical Swim Joy solar pool heating system is plumbed into existing pool plumbing. This drawing may not be just like every system you encounter; the feed and return plumbing on a solar system may be reversed, or it may be a different type of filter, or it may have additional equipment such as a chlorinator, pool cleaner, gas heater, etc. It may also have a long run of plumbing from the pool equipment to the solar collectors.

Whether the system is like this or not, Fig. 13.1 will help you understand the flow of water from the pool, through the pump, filter, solar system, and back to the pool. Study the diagram and become familiar with the valves needed to connect the solar collectors to existing plumbing.

Notice that the first check valve is plumbed in after the filter. This prevents the filter from being backwashed by the water draining down from the panels when the pump shuts off. The 3-way valve either diverts the water to the solar system or directly back to the pool. This 3-way valve should be a non-positive seal valve. This enables the water in the solar system to drain back to the pool when the pump shuts off. The 2-way valves on the solar feed and return lines allow you to isolate (completely shut off) the solar system.

1. Study the plumbing after the filter and decide where you are going to install the check valve and the PVC tee fitting (see Fig. 13.1). If you have auxiliary equipment, you may need to re-plumb a portion of your existing plumbing so this equipment is located after the solar system as indicated in Fig. 13.1.
2. Cut the pipe after the filter where you have decided to locate the check valve and where your solar return pipe will attach to your existing pool return line. If your pool plumbing is 1-½", and you are running 2" plumbing to your solar system, you should be using 2" valves and piping for all of your new plumbing. Therefore you will need (2) 2"x1-½" reducer bushings to adapt your new 2" fittings to the existing 1-½" pipe.
3. As discussed earlier in this manual, it is a good idea to assemble all pipe and fittings before cementing them just in case you make an error. Install a check valve on the pipe coming out of the filter. Be sure that the arrow showing flow direction is pointed away from the filter.
4. The 3-way valve will be installed next. It may come right next to the check valve, or you may have to use some pipe and fittings to locate it off the main line. As stated earlier, use as few 90-degree elbows as possible.
5. Install the 2-way valve to the solar feed line and then connect the other side of the 2-way valve to one of the ports on the 3-way valve.
6. Install the (2-1410-023) vacuum breaker about 4' up the feed line and above the top of the filter using a PVC tee and reducer bushing. Face the tee to the outside as shown in Fig. 13.1. Wrap the threads of the vacuum breaker with Teflon tape and screw it into the ¾" threaded reducer bushing.
7. Install the second 2-way valve to the solar return line.
8. Determine now where to locate the PVC tee fitting. The tee may be located right next to the 3-way valve or elsewhere depending on your system. Connect the tee fitting first to the solar return line, then to the 3-way valve, and finally to the pool return line.

13. Connecting the Feed & Return Lines to the Filtration System. - Cont.

9. Once you are satisfied with the plumbing arrangement, go back and cement together all the joints that you have not already cemented. Use good plumbing techniques and rags to protect the existing pool equipment.

NOTE: Use pipe clamps the same size as the outside diameter of your plumbing fittings to secure the pipe and fittings tightly to the wall.

NOTE: When cementing check valves, try to do so in a horizontal position to prevent cement from dripping into the spring loaded valve and cementing it closed! When this is not possible, use cement sparingly and allow it to dry slightly before inserting the pipe into the socket. When cementing to a 3-way valve, either remove the diverter from the valve or cement with the diverter turned away from any open port to prevent the cement from running onto the diverter cementing it in place!

For a truly professional looking installation, take time to clean the PVC pipe. Use a clean rag, pour PVC cleaner on it, and then wipe the dirt and identification marks off the pipe. Do this on all exposed pipe. This is also good preparation if you plan on painting the pipe to match the house color.

IF YOU ARE INSTALLING AN AUTOMATIC SYSTEM: The basic difference between the manual system just outlined and an automatic system is the use of a motorized 3-way valve. This 3-way valve is operated by a differential control which uses sensors to determine if the solar system is warmer or cooler than the pool water. This way, it can shut the solar system off when cloudy conditions exist and thereby generate the optimum performance from the solar investment. It also allows you to select a maximum pool water temperature so the solar system doesn't overheat the pool. It accomplishes this by the use of a sensor on the roof and a sensor installed into the pool plumbing. The directions included with the automatic system components will direct you in the installation of the control and sensors. The 3-way valve will be installed as described in above procedure.



14. Pressure Testing the Swim Joy Solar System.

Pressure testing the entire solar system provides for a trouble-free installation and takes only about fifteen minutes. Any weak PVC glue joint, fittings or pipe, and any improper panel clamp connections, will be evident while the system is put under 40 to 50 PSI of pressure.

1. Allow ample time for all glue joints to dry completely. Use this time to wrap up things and to clean up the job site.
2. Wrap the threads of the (2-2015-101) pressure test "T" assembly, ½" ball valve and (2-3020-001) pressure gauge with Teflon tape. Replace temporarily the vacuum breaker with the (2-2015-101) pressure test "T" assembly. Thread the ½" ball valve and pressure gauge into the pressure test "T" assembly.
3. Attach a garden hose to the ½" ball valve. Make sure the ½" ball valve is in the "OFF" position.
4. Turn the solar system on to allow the pool pump to completely fill the solar system. (If the pool pump is not operational, shut off the ball valve on the feed line and use the garden hose to fill the system.)
5. Once the solar system is completely full of water, turn off the pool pump or turn the 3-way valve to bypass the solar system. Quickly turn off the ball valves on both the feed and return lines.
6. Turn on the city water to the garden hose and open the ½" ball valve on the pressure test "T" assembly until the pressure gauge reads 40 to 50 PSI and then turn off the ½" ball valve. Turn off city water.
7. With the system under pressure, check the whole system for any leaks. A drop in pressure on the pressure gauge indicates a leak in the system.
8. If there are leaks, open the ball valve on the return line to relieve the pressure. Repair any leaks. Repeat the pressure testing procedures as needed.
9. Return a system to normal when through with the pressure testing. Be sure to open both ball valves and replace the pressure test "T" assembly with the vacuum breaker.

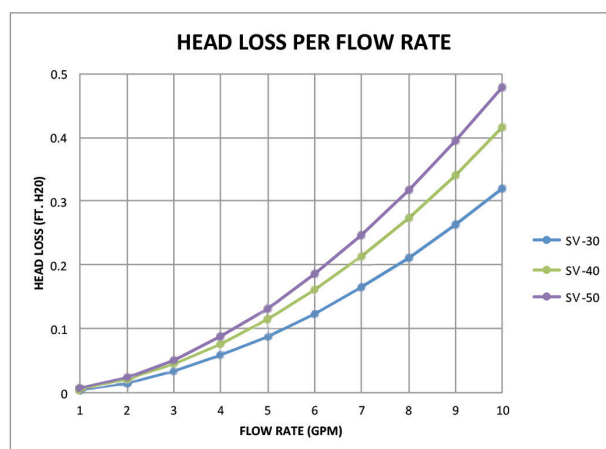

15. Operation & Check-out Procedures.

BEFORE YOU RUN WATER THROUGH THE SYSTEM:

1. Allow the cemented fittings adequate time to dry per manufacturer's directions.
2. Verify that the check valves, control valves, and vacuum breakers are installed properly.
3. Verify that all plastic panel clamps are tight.
4. Pressure test the system as described on page 27.
5. Verify that all anchors are secure and that adequate silicone was used to prevent any roof leaks.
6. Be sure all collector riser tubes are snapped into the spacer bars (except where they go around obstructions).
7. Be sure that the collector riser tubes are NOT rubbing on the roof surface between the spacer bars. If they are, adjust the spacer bars as needed to prevent this or a hole may develop in the riser tube.
8. Be certain that the system will automatically drain down when the pump is shut off or that enough manual drain valves have been installed.
9. Verify that all pipe runs are properly supported with pipe clamps.

TURNING THE SYSTEM ON

1. Turn the pool pump off.
2. Turn the 3-way valve so the "closed" indicator points toward the pool return side of the valve.
3. Be sure that the 2-way valves on the feed and return lines are open.
4. Turn the pool pump on.
5. Set the pool pump timer, if used, so that the pump will run when the sun is shining on the solar collectors; usually 10:00 AM to 4:00 PM, but this will vary with geographical location and time of year.
6. When the solar system is running, you should notice:
 - A slightly higher pressure reading on the pressure gauge.
 - At midday, if the sun is out, warmer water should be coming into the pool. This water should be 3° to 5°F warmer than the pool temperature. Use the back of your hand to better feel the difference in water temperature.
 - All the collectors should feel cool to the touch when the sun is on them.



15. Operating & Check-Out Procedures. - Cont.

7. During the cooler months of the year, it is essential that the pool surface be covered at night with a "pool blanket" to maintain a comfortable water temperature. Low nighttime temperatures can lower the water temperature more than the solar can recover during the day.

TURNING THE SYSTEM OFF

1. Turn the pool pump off.
2. Turn the 3-way valve so the "closed" indicator points toward the solar feed side of the valve.
3. If isolating the collectors, close the 2-way valve on the feed line after you are sure all the water has drained out of the collectors and plumbing.
4. Turn the pool pump on to filter the pool as needed.

That's all there is to it. You have installed a Swim Joy solar pool heating system that has been tested and proven world-wide for quality and reliability. If you run into any problems with your installation or have any future problems, call your Swim Joy representative.

BE SURE TO COMPLETE THE PRODUCT REGISTRATION INFORMATION ON THE BACK OF THE WARRANTY AND REMIND YOUR CUSTOMER TO COMPLETE THE PRODUCT REGISTRATION AT UMASOLAR.COM.

CONGRATULATIONS!

If you have carefully followed the steps in this manual, you now have an efficient, professional looking Swim Joy solar pool heating system.

16. Troubleshooting.

PROBLEM.	CAUSE	SOLUTION
THERE ARE AIR BUBBLES IN THE POOL WHEN THE SOLAR HEATER IS OPERATING	<p><i>1. If the pump is making more noise, there may be air coming into the pump through an air leak on the suction side of the pump due to the pump working harder to move the water through the solar system.</i></p>	<p>A. Be sure pump trap lid is on tight. B. Check the "O" ring on the pump trap lid. clean, lubricate, or replace as needed. C. If you have a suction type pool cleaner, remove it. If this improves the air bubbles, only use it when not operating the solar. D. If you have a clear lid on the pump and can see air bubbles in the trap, run water over the lid and each joint individually to see if the air bubbles will clear up using a garden hose. If there is not a clear lid, listen to pump noise for a smoother operation, repair any air leaks.</p>
	<p><i>2. If the vacuum breaker is installed on the roof, there is not enough water pressure in the solar system to keep the vacuum relief valve closed and it is allowing air to be drawn into the water as it flows by the valve.</i></p>	<p>A. Be sure filter is clean. Backwash to reduce pressure. B. If it's an older system, check for debris or scale in the mouth of the vacuum relief valve and clean if necessary. C. Use the (2-2015-019) on the return line to throttle the flow back to produce more back pressure on the system.</p>



16. Troubleshooting

PROBLEM.	CAUSE	SOLUTION
<p>SOME OF THE SOLAR PANELS ARE WARM TO THE TOUCH WHILE OTHERS ARE COOL TO THE TOUCH</p>	<p>1. There is not equal flow through all of the panels. Warm panels indicate low water flow. Pump issue.</p>	<p>A. Be sure filter is clean. Backwash to reduce pressure.</p> <p>B. The pump may not be providing enough water to the solar system. Check water flow using a flow meter. Increase pump horsepower if needed to maintain recommended flow.</p> <p>C. If there is a suction type cleaner in the pool, remove it. If this eliminates the problem, use it only when the solar system is off.</p>
	<p>1. There is not equal flow through all of the panels. Warm panels indicate low water flow. Install issue.</p>	<p>A. If the system is a single row array and there is adequate flow, use the (HBV) on the return line to throttle the flow back to produce more back pressure on the system. This will even out the flow through the panels. If the array contains more panels than the maximum recommended on page 7 of this manual, change the array to a double row or single row split feed as show in (Fig. 6.2 and 6.3).</p> <p>B. If the system is a double row or a single row split feed array and there is adequate flow, install a ball valve on the return side of the set of panels that are the coolest to the throttle. Back the flow through these panels and force more water through the warmer panels. If any section of the array contains more panels than the maximum recommended on page 9 of the manual, make changes as needed to correct this.</p>

16. Troubleshooting

PROBLEM.	CAUSE	SOLUTION
THE AREA LEAKS BETWEEN THE HEADERS AT THE PLASTIC PANEL CLAMPS	1. PPC latch is not tight enough to seal the joint.	Slide the latch farther across the connection between top and bottom half of the clamp.
	2. PPC is not seated squarely in grooves.	Disassemble PPC and verify that the gasket is seated properly.
THERE IS A PIN HOLE LEAK IN ONE OF THE RISER TUBES	1. If it's a new installation, it may be a manufacturing defect.	Contact your distributor for warranty repair information.
	2. Riser tubes are rubbing on roof surface.	Contact distributor for a repair kit and adjust the spacer bars to prevent future damage.
	3. Birds or squirrels have damaged the tubes.	Contact distributor for a repair kit and adjust the spacer bars to prevent future damage.
THE 3-WAY OR BALL VALVE WILL NOT TURN	Internal parts need to be lubricated or replaced.	If the valve has a grease fitting, turn it clockwise to inject grease into valve then turn the diverter past the grease fitting to spread the grease. If the grease fitting is dry, fill it with silicone grease. If there is not a fitting, disassemble valve and lubricate with silicone grease. Replace worn or broken parts.
THE AUTOMATIC CONTROL SYSTEM IS NOT WORKING	Various	Consult the manual for the automatic system you have.



16. Troubleshooting. - Cont.

PROBLEM.	CAUSE	SOLUTION
THE WATER COMING FROM THE SOLAR SYSTEM IS NOT AS WARM AS IT SHOULD BE	1. The water is flowing too fast through the panels.	Test the water flow rate. Water flow through a single panel should be less than 10 gallons per minute. Adjust the 3-way valve to bypass some of the water.
	2. Seasonal normal operation.	In the cooler months of the year, or on cool, partly cloudy days, temperature rise through the panels may only be 2° or 3°. Use the back of your hand to feel the water temperature difference at the pool return inlet.

17. Repair Procedures.

NOTE: The Swim Joy solar collector is a very durable product, but there are a few steps you should take to protect its longevity.

- (1) Try to avoid walking on the collectors. If you cannot avoid it, always wear soft-soled shoes.
- (2) Do not install Swim Joy collectors during temperatures lower than 35 degrees.

If any of the riser tube in a Swim Joy collector should become damaged for any reason, it can be repaired using the (2-3020-025) repair tool kit and (2-1020-007) repair plugs. The repair tool kit consists of a 1/4" repair chisel, an insert tool, and a (PVC) carrying case. Follow instructions for repair:

1. Utilizing the repair chisel, cut the damaged riser as close as possible to the header carefully avoiding damaging adjacent riser. (The sloped side of the chisel should face away from the header).

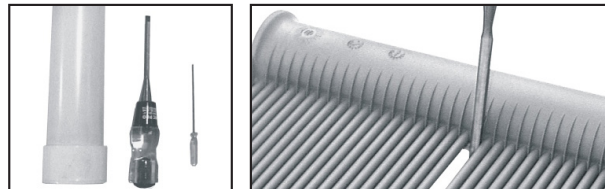

2. Spray the shaft of the insert tool and the rubber insert with silicone spray. Insert the insert tool into the rubber insert. By holding the rubber insert with one hand and the insert tool with the other, gently stretch the rubber insert. As you do, push the rubber insert all of the way into the header's opening. Stretching the rubber insert first allows for easier insertion into the header.

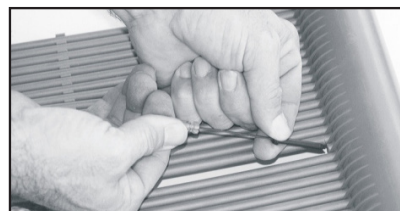
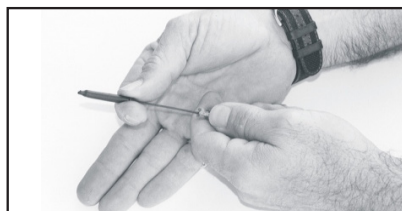

3. Pull out the rubber insert tool. Using your fingers or channel-lock pliers, push a poly-insert into the rubber insert as far as you can.

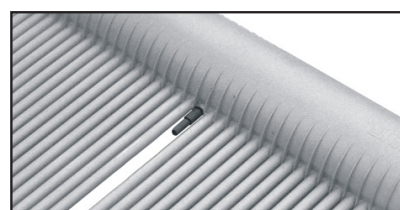
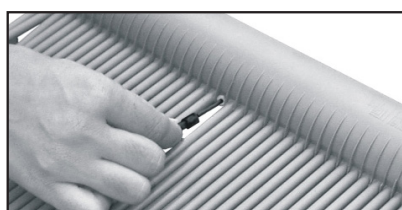

17. Repair Procedures. - Cont.

4. Cut the riser tube to the desired length and slide it over the stub of the poly-insert for a straight, eye pleasing fit.

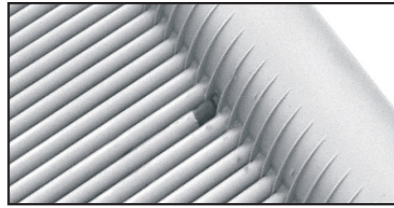
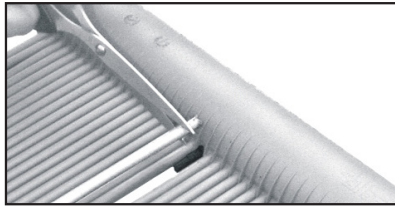

5. REPEAT steps 1-4 for the other end of the riser tube. (At the opposite header).

Swim Joy

RESIDENTIAL INSTALLATION MANUAL SWIM JOY SOLAR POOL HEATER



Swim Joy is the first solar pool collector in the world to achieve the elite status of ISO9001:2000 Certified. Relatively few manufacturers have the privilege of placing the ISO 9001:2008 emblem on their products. Only those companies performing at the highest levels in their industries can meet the stringent requirements specified by this demanding international standard. The technical and engineering expertise of Swim Joy and their relentless pursuit of continuous product improvement have earned them the world renowned ISO 9001:2008 certification. Over the two year process necessary to gain certification, their customer service record, product failure rate, and engineering processes were all carefully scrutinized and found deserving of ISO 9001:2008.



The solar energy system described by this manual, when properly installed and maintained, meets or exceeds the minimum standard established by the Solar Rating and Certification Corporation (SRCC). This certification does not imply endorsement or warranty of this product by the SRCC.



An Environmentally Safe Product is one that helps to preserve and protect our environment. The Swim Joy Solar System does just that. An average pool in the United States, when heated by a gas heater, will introduce into our atmosphere 58 tons of CO₂ and 108 pounds of NO_x over a ten-year period. A Swim Joy Solar System that is cost effective, durable, and worry-free will introduce no such health hazards into our air. Your Swim Joy system will provide you with natural, safe, and free energy year after year.